

# *punt*

ART, CRAFT & DESIGN



## MITIS

TECHNICAL INFORMATION SHEET

# MITIS - MITIX

BY MARIO RUIZ, 2012

*punt*



---

## PRODUCT TYPE

Table

Collection of tables with a solid appearance and exquisite details both in the tabletop and in its slotted trestle legs.

---

## TIPOLOGÍA DE PRODUCTO

Mesa alta

Colección de mesas de aspecto sólido y detalles exquisitos tanto en el tablero como en sus patas ranuradas de tipo caballete.

## DETAILS. DETALLES



# MITIS - MITIX

BY MARIO RUIZ, 2012

**punt**

MITIS H75 cm - 29.5 in

## MTS102

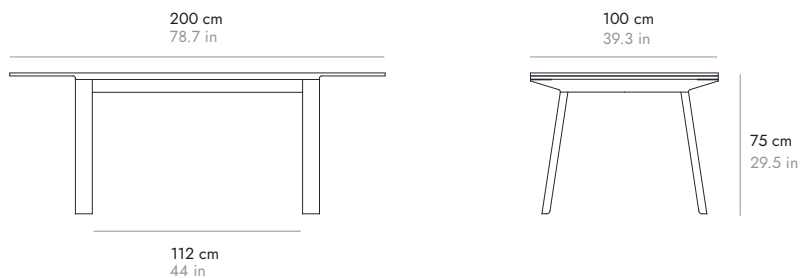
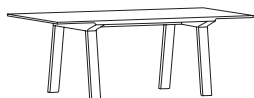

## MTS104

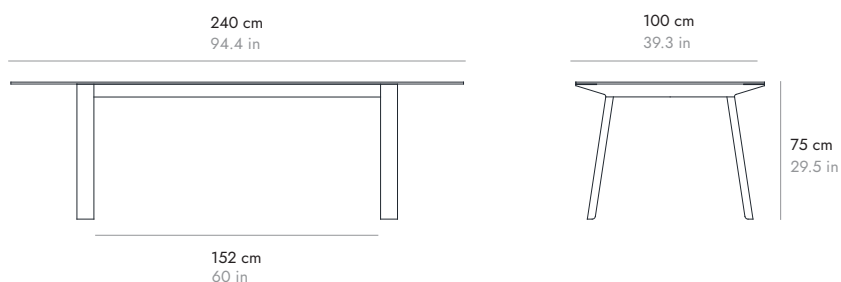
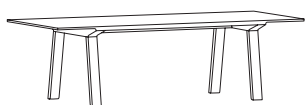

## MTS107

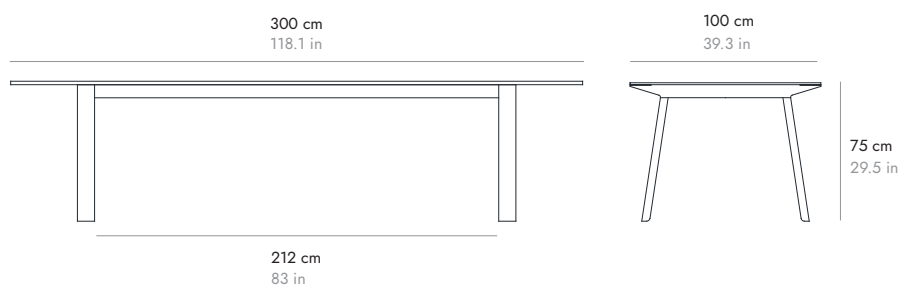

# MITIS - MITIX

BY MARIO RUIZ, 2012

**punt**

MITIS H110 cm - 43.3 in

## MTS402

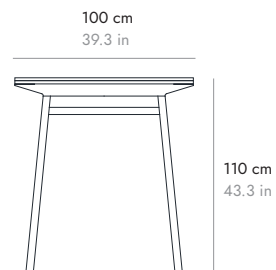
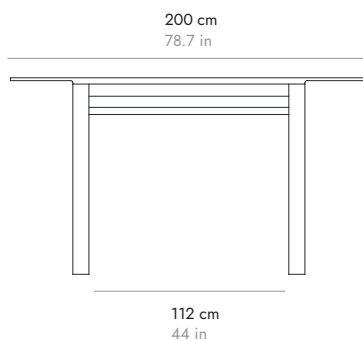

## MTS404

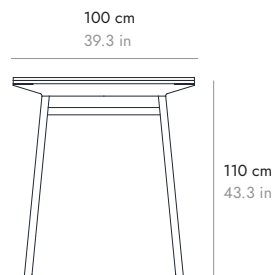
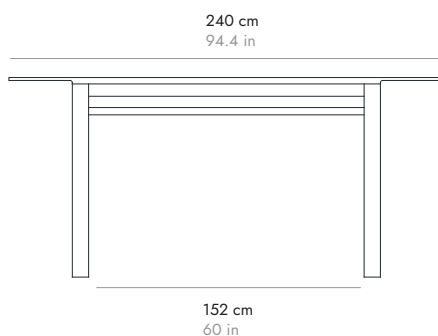
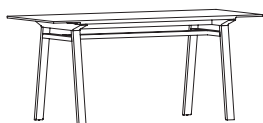

## MTS407

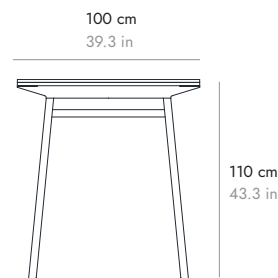
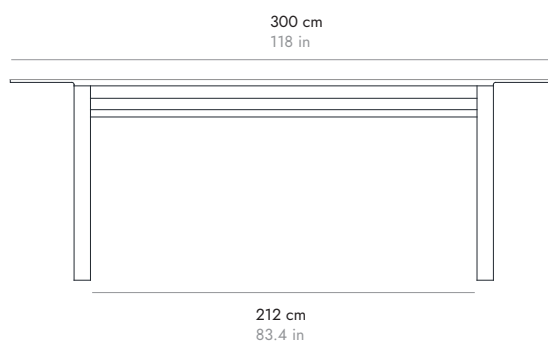

# MITIS - MITIX

BY MARIO RUIZ, 2012

**punt**

MITIX H75 cm - 29.5 in

## MTX101

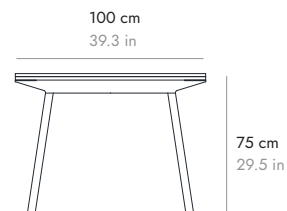
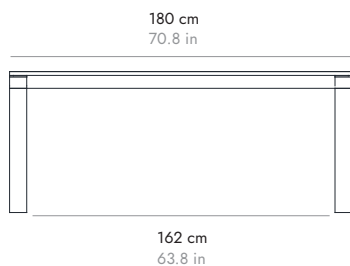

## MTX102

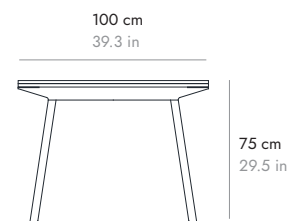
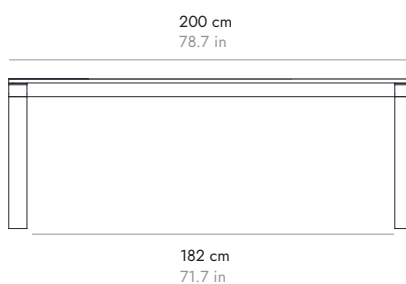

## MTX103

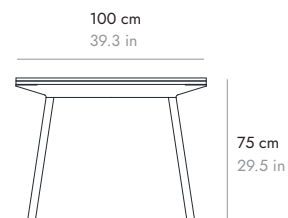
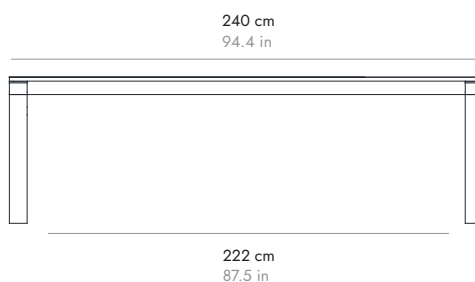

# MITIS - MITIX

BY MARIO RUIZ, 2012

**punt**

## SPECIAL DIMENSIONS MEDIDAS ESPECIALES

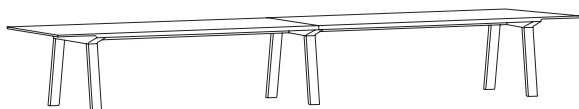

Mitis and Mitix tables are available in special sizes upon request. Please contact our sales department for a quotation.

Las mesas Mitis y Mitix está disponible en medidas especiales bajo pedido. Por favor consulte con el departamento comercial para su cotización.

## COMPOSITIONS COMPOSICIONES

**MITIS104 + HUG**

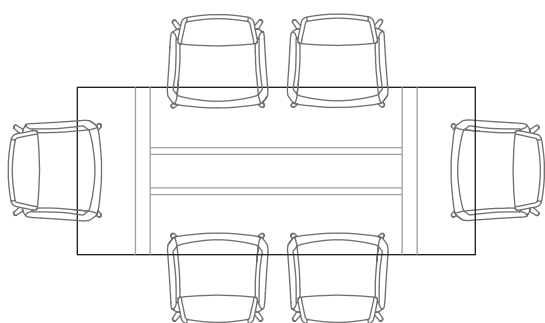

240 cm  
94.4 in

**MITIX103 + HUG**

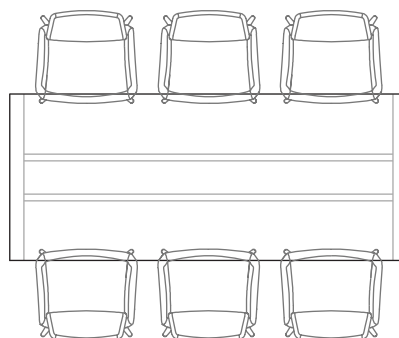

240 cm  
94.4 in

## ACCESORIES MITIS ACCESORIOS MITIS



**ACC069**

### MITIS CABLE GROMMET

Cable grommet recessed in the leg of the Mitis table, which allows cables to be placed inside its section. Maximum cable diameter 7 mm - 0.27 in.

### PASACABLES MITIS

Pasacables empotrado en la pata de la mesa Mitis, que permite colocar cables dentro de su sección. Diámetro máximo del cable 7 mm - 0.27 in.

## ACCESORIES ACCESORIOS



Aluminum grommet to be placed on the top, in order to allow the passage of the cables of electronic elements and to hide them under the table.

Pasacables de aluminio para situar en la cara superior del sobre, con el objetivo de permitir el paso de los cables de elementos electrónicos y que queden ocultos bajo la mesa.

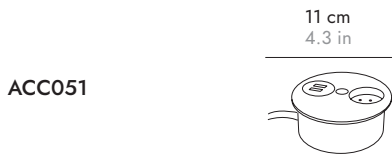

1 power sockets + 2 USB ports.

1 enchufe + 2 puertos USB.



Recessed box with metal cover for multiple connections in white or black. ACC133 electrification is not included.

Caja empotrable con tapa metálica para conexiones múltiples en color blanco o negro. No incluye electrificación ACC133.

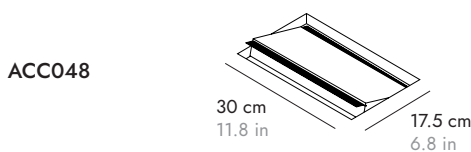

Pivoting cable entry with wooden cover (continuity with the wood veneer pattern). ACC133 electrification is not included.

Pasacables pivotante con tapa de madera (continuidad con el dibujo de la chapa). No incluye electrificación ACC133.

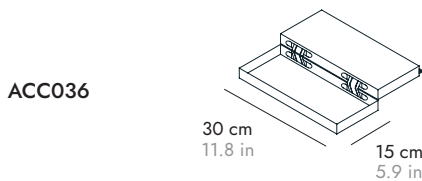

Hinged grommet embedded in the finish of the top. ACC133 electrification is not included.

Pasacables con bisagra incrustado en el acabado de la encimera. No incluye electrificación ACC133.

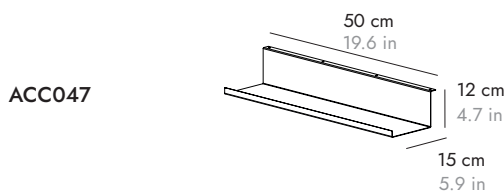

Metal black trag. The duct is fixed on the underside of the table top so the cables can be threaded through it.

Canaleta de metal negro. Se fija en la parte inferior del tablero de la mesa, de modo que los cables descansan sobre ella.

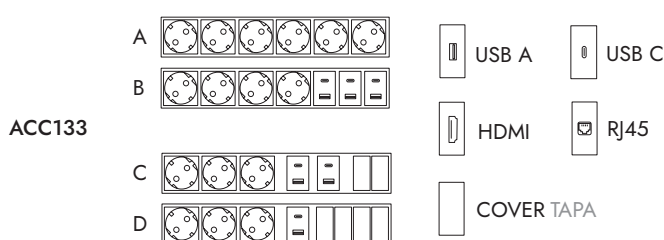

Electrifications A and B have only charging elements (plugs and USB), while electrifications C and D combine charging and multimedia elements such as RJ45, HDMI, USB A or USB C.

Las electrificaciones A y B disponen únicamente de elementos de carga (enchufes y USB), mientras que en las electrificaciones C y D se combinan los elementos de carga y multimedia como RJ45, HDMI, USB A o USB C.

## ACCESSORIES ACCESORIOS

---

ACC066



Circular machined hole made to measure.

Hueco circular mecanizado a medida.

---

ACC064

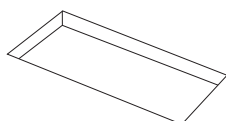

Rectangular machined hole made to measure.

Hueco rectangular mecanizado a medida.

---

# MITIS - MITIX

BY MARIO RUIZ, 2012

**punt**

## MATERIALS

Wood.

Top in MDF E1 board (low formaldehyde content) in oak or natural walnut with 2 mm solid wood edge, and legs in oak or solid walnut.

## Top & legs Sobres y patas

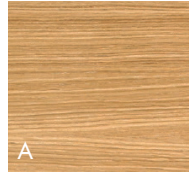

**SUPER MATT OAK**  
ROBLE SÚPER MATE  
CHÊNE SUPERMATE  
EICHE SUPERMATT  
ROVERE OPACO



**WHITENED OAK**  
ROBLE BLANQUEADO  
CHÊNE BLANCHI  
EICHE WEISS  
ROVERE SBIANCATO



**WALNUT STAINED OAK**  
ROBLE TEÑIDO NOGAL  
CHÊNE TEINTÉ NOYER  
EICHE NUSSBAUM  
GEBEIZT  
ROVERE TINTO NOLE

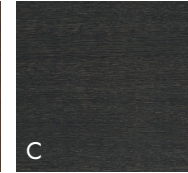

**DARK GREY STAINED OAK**  
ROBLE TEÑIDO GRIS  
CHÊNE TEINTÉ GRIS  
EICHE DUNKELGRAU  
GEBEIZT  
ROVERE TINTO GRIGIO  
SCURO

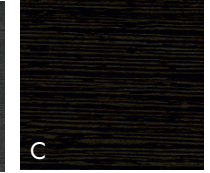

**EBONY STAINED OAK**  
ROBLE TEÑIDO ÉBANO  
CHÊNE TEINTÉ ÉBÈNE  
EICHE EBENHOLZ  
GEBEIZT  
ROVERE TINTO ÈBANO

## MATERIALES

Madera.

Sobre de tablero MDF E1 (bajo contenido en formaldehído) aplacado en madera de roble o nogal natural con canto en madera maciza de 2 mm, y patas en roble o nogal macizo.



**SUPER MATT WALNUT**  
NOGAL SÚPER MATE  
NOYER SUPER MATE  
WALNUSS SUPERMATT  
NOCE OPACO

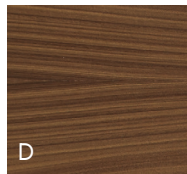

**WALNUT STAINED WALNUT**  
NOGAL TEÑIDO NOGAL  
NOYER TEINTÉ NOYER  
WALNUSS WALNUSS  
GEBEIZT  
NOCE TINTO NOCE

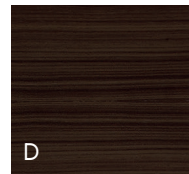

**DARK STAINED WALNUT**  
NOGAL TEÑIDO OSCURO  
NOYER TEINTÉ FONCÉ  
WALNUSS DUNKEL  
GEBEIZT  
NOCE TINTO SCURO