

BONALDO

Salomé

Designer: **Mauro Lipparini**



Perfect in its dynamic as a holder, every detail of the Salomé clothes valet stand contributes to the overall balance. Its design consists of delicate geometric shapes marked by precise vertical signs in which the luminous patterns of the transparent globe seem to dance with mirrored reflections. Lights, lines and materials as fundamental features of an object destined to perform a daily service that becomes an

emblem of an intimate relationship with the sleeping area: the beauty of the Salomé bedroom valet stand lies in the charm of the harmony between the forms and the intensity of its presence, a strongly scenographic design. The Salomé valet stand comes with a metal frame and tray in different finishes. A version with lampshade is also available.



Data sheet

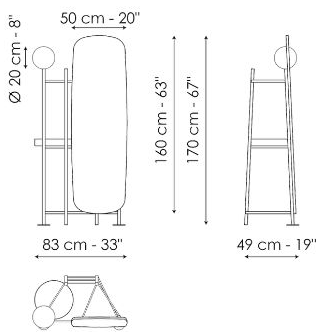
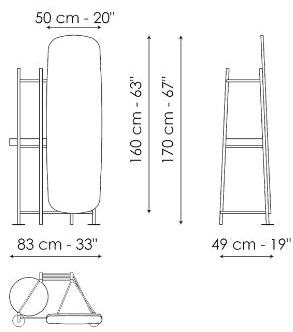

Salomé

Width: 80cm
Depth: 49cm
Height: 170cm

Salomé

Width: 83cm
Depth: 49cm
Height: 170cm

Finishes

STRUCTURE

Plus Metal



Painted metal
Mat bronze

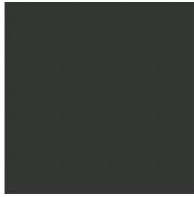

Painted metal
Mat lead

TRAY

Plus Metal



Painted metal
Mat bronze

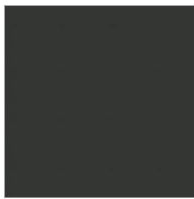

Painted metal
Mat lead



Painted metal
Mat brass

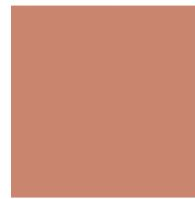

Painted metal
Mat copper

LAMPSHADE

Transparent Glass

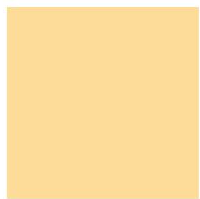

Glass
Amber



Glass
Smoked

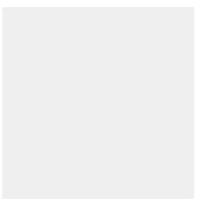

Glass
Transparent

You can find the complete collection of Bonaldo fabrics and leathers on the website <https://www.bonaldo.biz/>

