

***punt***

ART, CRAFT & DESIGN



**VELASCA**

TECHNICAL INFORMATION SHEET

# VELASCA

BY PALOMBA SERAFINI ASSOCIATI, 2025

**punt**



## PRODUCT TYPE

Desk

Architectural, linear and minimalist is the proposal by Ludovica+Roberto Palomba for Punt. In a delicate balance of shapes, Velasca is presented as a versatile and functional desk capable of adapting to different spaces. Wood is in charge of providing warmth and texture thanks to the refined and painstaking detail of its slatted doors. A masterpiece that does not fail to thrill and that seems to create a sculpture suspended in time.

## TIPOLOGÍA DE PRODUCTO

Escritorio

Arquitectónica, lineal y minimalista es la propuesta de Ludovica+Roberto Palomba para Punt. En un delicado equilibrio de formas, Velasca se presenta como un escritorio versátil y funcional capaz de adaptarse a diferentes espacios. La madera es la encargada de aportar calidez y textura gracias al refinado y cuidado detalle de sus puertas alistonadas. Una obra maestra que no renuncia a emocionar y que parece crear una escultura suspendida en el tiempo.

## DETAILS DETALLES



# VELASCA

BY PALOMBA SERAFINI ASSOCIATI, 2025

**punt**

## COMPOSITIONS COMPOSICIONES

The Velasca executive table is composed of a desk, available in different sizes. Choose from one of the table sizes and combine it with the three-door sideboard VLS300.

La mesa ejecutiva Velasca está compuesta por un escritorio de diferentes medidas disponibles. Elige entre una de las medidas de mesa y combínala con el aparador de tres puertas VLS300.

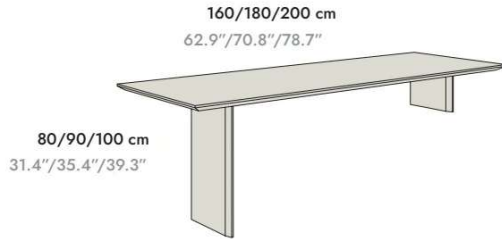

VLS300 Sideboard with 3 doors Aparador con 3 puertas

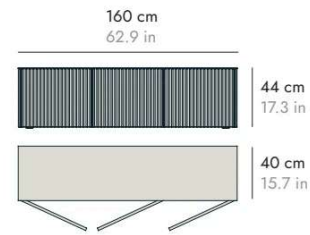

## SIDEBOARD PLACEMENT POSICIÓN APARADOR

The sideboard can be placed either on the right or on the left. In case of including cable grommet the position must be fixed and cannot be modified.

El aparador puede colocarse tanto a la derecha como a la izquierda. En caso de incluir pasacables la posición deberá ser fija y no podrá modificarse.

Left sideboard position  
Posición izquierda aparador

Recommended option  
Opción recomendada

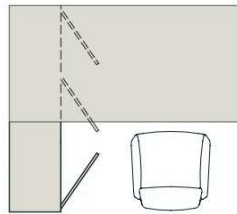

Right position sideboard  
Posición derecha aparador

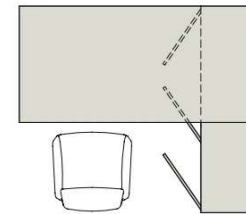

## EJEMPLOS EXAMPLES

1) DESK 160 x 80 cm + VLS300+ HUG

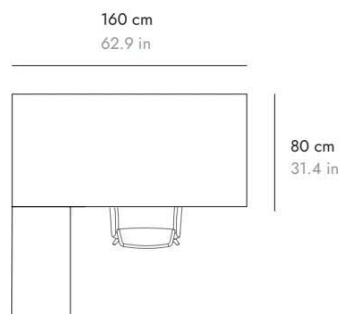

2) DESK 200 x 100 cm + VLS300+ HUG

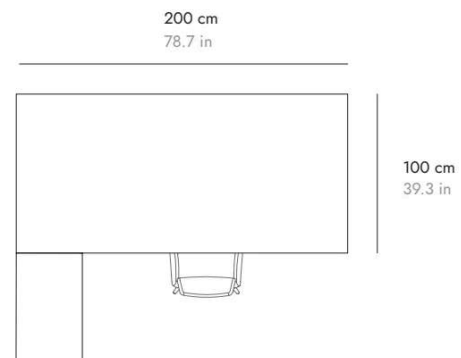

# VELASCA

BY PALOMBA SERAFINI ASSOCIATI, 2025

**punt**

## DIMENSIONS DIMENSIONES

### LENGTH LARGO

160 cm 62.9 in

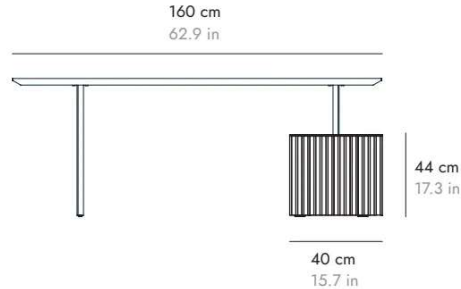

### WIDTH ANCHO

160 cm x 80 cm  
62.9 in x 31.4 in

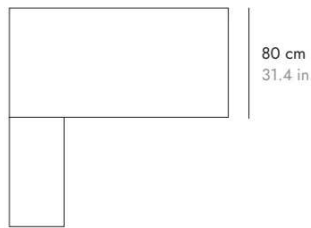

160 cm x 90 cm  
62.9 in x 35.4 in

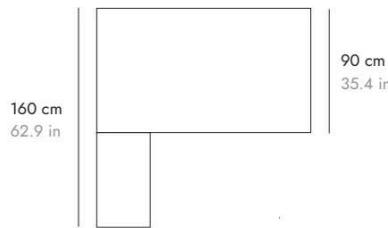

160 cm x 100 cm  
62.9 in x 39.3 in

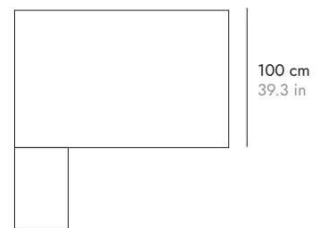

### LENGTH LARGO

180 cm 70.8 in

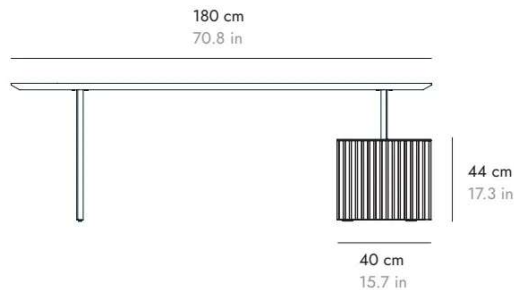

### WIDTH ANCHO

180 cm x 80 cm  
70.8 in x 31.4 in

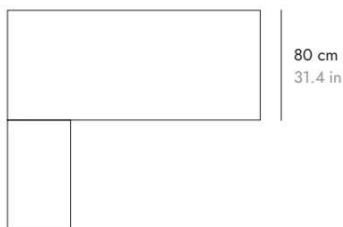

180 cm x 90 cm  
70.8 in x 35.4 in

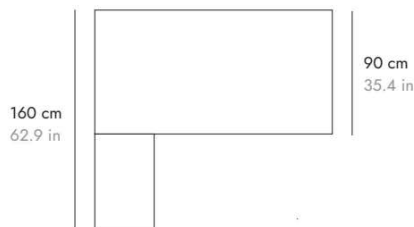

180 cm x 100 cm  
70.8 in x 39.3 in

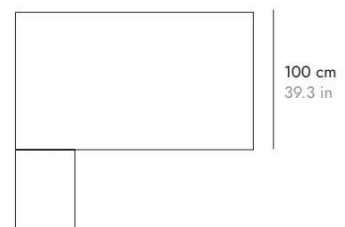

# VELASCA

BY PALOMBA SERAFINI ASSOCIATI, 2025

*punt*

## DIMENSIONS DIMENSIONES

### LENGTH LARGO

200 cm 78.7 in

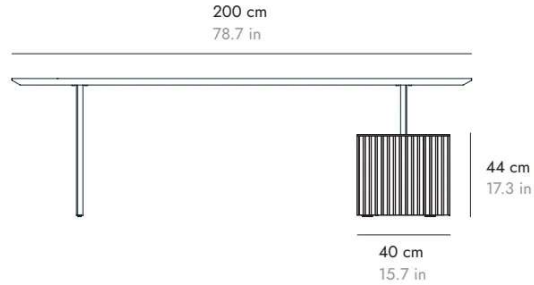

### WIDTH ANCHO

200 cm x 80 cm

78.7 in x 31.4 in



200 cm x 90 cm

78.7 in x 35.4 in

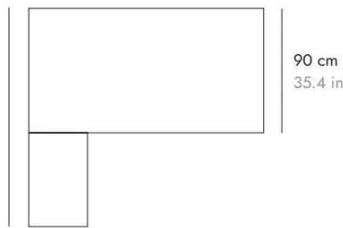

200 cm x 100 cm

78.7 in x 39.3 in

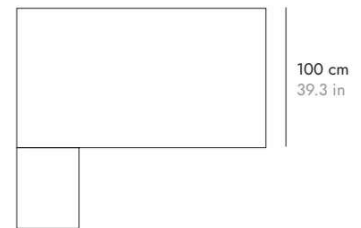

**VELASCA**

BY PALOMBA SERAFINI ASSOCIATI, 2025

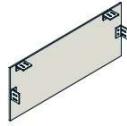
**punt****ACCESORIES EXECUTIVE TABLE ACCESORIOS MESA EJECUTIVA****FVL****FVL160**

Modesty panel for 160 cm - 62.9" table.  
Faldón para mesa de 160 cm - 62.9".

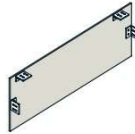
**FVL180**

Modesty panel for 180 cm - 70.8" table.  
Faldón para mesa de 180 cm - 70.8".

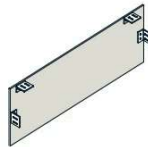
**FVL200**

Modesty panel for 200 cm - 78.7" table.  
Faldón para mesa de 200 cm - 78.7".

**ACCV11**

Ventilation grills at both ends of the rear of the sideboard together with cable grommet hole.

Rejillas de ventilación en los dos extremos de la trasera del aparador junto con agujero pasacables.

**CER100**

Lock + 2 individual keys for a door or a drawer.

Cerradura + 2 llaves individuales para puerta o cajón.

**CER102**

Lock + 2 individual keys for double door.

Cerradura + 2 llaves individuales para puerta doble.

**CER101**

1 master key that opens several doors or drawers of different furniture.

1 llave amaestrada que abre varias puertas o cajones de diferentes muebles.

# VELASCA

BY PALOMBA SERAFINI ASSOCIATI, 2025



## ACCESORIES EXECUTIVE TABLE ACCESORIOS MESA EJECUTIVA

ACC052

6.5 cm  
2.5 in



Aluminum grommet to be placed on the top, in order to allow the passage of the cables of electronic elements and to hide them under the table.

Pasacables de aluminio para situar en la cara superior del sobre, con el objetivo de permitir el paso de los cables de elementos electrónicos y que queden ocultos bajo la mesa.

ACC051

11 cm  
4.3 in



1 power sockets + 2 USB ports.

1 enchufe + 2 puertos USB.

ACC059

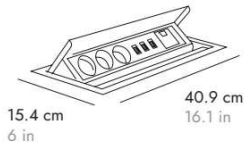

Recessed box with metal cover for multiple connections in white or black. ACC133 electrification is not included.

Caja empotrable con tapa metálica para conexiones múltiples en color blanco o negro. No incluye electrificación ACC133.

ACC048

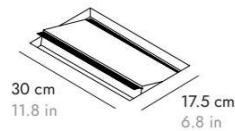

Pivoting cable entry with wooden cover (continuity with the wood veneer pattern). ACC133 electrification is not included.

Pasacables pivotante con tapa de madera (continuidad con el dibujo de la chapa). No incluye electrificación ACC133.

ACC036

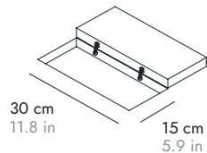

Hinged grommet embedded in the finish of the top. ACC133 electrification is not included.

Pasacables con bisagra incrustado en el acabado de la encimera. No incluye electrificación ACC133.

ACC047

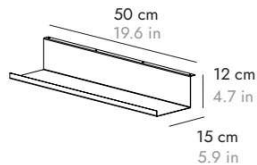

Metal black tray. The duct is fixed on the underside of the table top so the cables can be threaded through it.

Canaleta de metal negro. Se fija en la parte inferior del tablero de la mesa, de modo que los cables descansan sobre ella.

ACC133

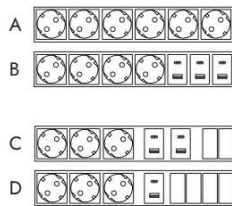

Electrifications A and B have only charging elements (plugs and USB), while electrifications C and D combine charging and multimedia elements such as RJ45, HDMI, USB A or USB C.

Las electrificaciones A y B disponen únicamente de elementos de carga (enchufes y USB), mientras que en las electrificaciones C y D se combinan los elementos de carga y multimedia como RJ45, HDMI, USB A o USB C.

# VELASCA

BY PALOMBA SERAFINI ASSOCIATI, 2025

*punt*

## ACCESORIES EXECUTIVE TABLE ACCESORIOS MESA EJECUTIVA

---

ACC066

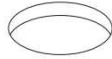

Circular machined hole made to measure.

Hueco circular mecanizado a medida.

---

ACC064

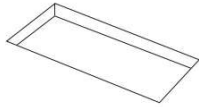

Rectangular machined hole made to measure.

Hueco rectangular mecanizado a medida.

---

# VELASCA

BY PALOMBA SERAFINI ASSOCIATI, 2025

**punt**

## MATERIALS

Interior and exterior of units, tops, legs and plinths in natural oak veneered MDF board.

Doors and sides of the units are made of solid oak wood. Each module includes an interior shelf with fixed position at half height. Invisible hinge fittings.

Handleless hinged doors with 105° opening with concealed hinges.

Decorative top and plinths with thermo-lacquered inlaid iron metal reinforcement.

Legs and modules with integrated adjustable feet.

Sideboard is supplied assembled.

## MATERIALES

Interior y exterior de los módulos, tapas, patas y zócalos de tablero MDF aplacado en madera de roble natural.

Alistonado de puertas y costados de los módulos de madera maciza de roble. Cada módulo incluye un estante interior de posición fija a mitad de altura. Herrajes bisagra invisible.

Puertas batientes sin tiradores con apertura de 105° con bisagras ocultas.

Tapa embellecedora y zócalos con refuerzo metálico embutido de hierro termo-lacado.

Patas y módulos con pies regulables integrados.

El aparador se sirve montado.

## Wooden parts Partes en madera



**A**  
SUPER MATT OAK  
ROBLE SÚPER MATE  
CHÊNE SUPERMATE  
EICHE SUPERMATT  
ROVERE OPACO

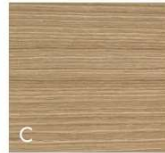

**C**  
WHITENED OAK  
ROBLE BLANQUEADO  
CHÊNE BLANCHI  
EICHE WEISS  
ROVERE SBIANCATO



**C**  
WALNUT STAINED OAK  
ROBLE TEÑIDO NOGAL  
CHÊNE TEINTÉ NOYER  
EICHE NUSSBAUM  
GEBEIZT  
ROVERE TINTO NOLE

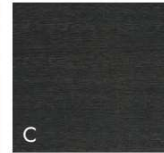

**C**  
DARK GREY STAINED OAK  
ROBLE TEÑIDO GRIS  
CHÊNE TEINTÉ GRIS  
EICHE DUNKELGRAU  
GEBEIZT  
ROVERE TINTO GRIGIO  
SCURO

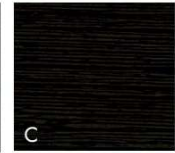

**C**  
EBONY STAINED OAK  
ROBLE TEÑIDO ÉBANO  
CHÊNE TEINTÉ ÉBÈNE  
EICHE EBENHOLZ  
GEBEIZT  
ROVERE TINTO ÉBANO

## *punt*

Punt Mobles XXI, S. L. , B-98387327  
C/ Islas Baleares, 48, Apdo. correos 14  
46988 Fuente del Jarro, Valencia, Spain

T. +34 961 343 270/ 72  
F. +34 961 476 190  
info@puntmobles.com

[www.puntmobles.com](http://www.puntmobles.com)

