

BONALDO

Alicanto

Designer: Gabriele & Oscar Buratti



The Alicanto sideboards are available in two versions: a horizontal version with four doors and a vertical version with two doors and an open upper unit, designed to be used individually or combined in coordinated compositions.

The different heights define distinct proportions and characters: in the horizontal version (available in two heights, Alicanto and Alicanto midi), the volume develops in a more compact way, while in the Alicanto high version the open upper unit emphasises verticality and lightens the overall perception. An elegant and discreet detail, the result of a precise design choice, is represented by the side panels with a lenticular section, which extend down to the floor to form the base of the piece.

The structure of Alicanto is made of brown oak or charcoal oak. The top can be in wood, for a monomaterial finish, or in ceramic, introducing a refined contrast between materials.

Fiche de données

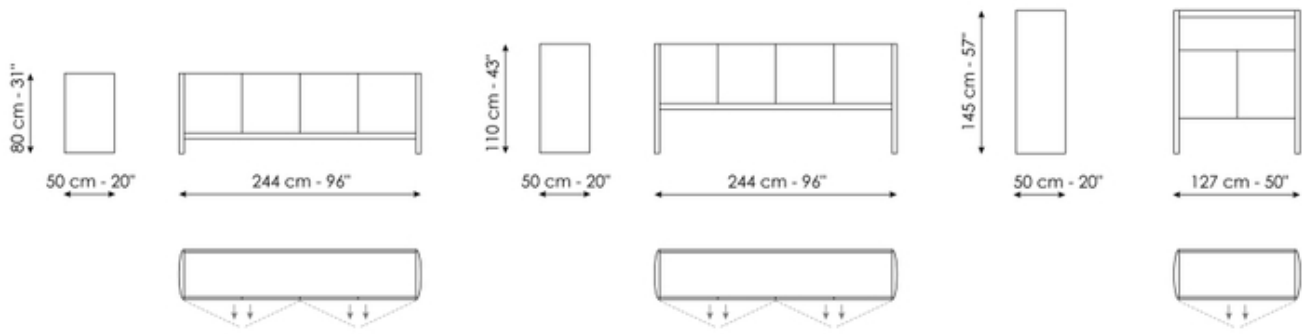

Alicanto

Longueur: 244cm
Profondeur: 50cm
Hauteur: 80cm

Alicanto midi

Longueur: 244cm
Profondeur: 50cm
Hauteur: 110cm

Alicanto high

Longueur: 127cm
Profondeur: 50cm
Hauteur: 145cm

Finishes

Structure



Bois plaqué
Chêne charbon

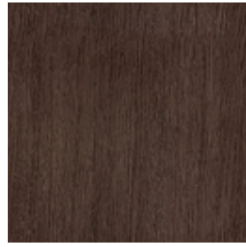

Bois plaqué
Chêne brown

Plateau



Céramique opaque
Augusta

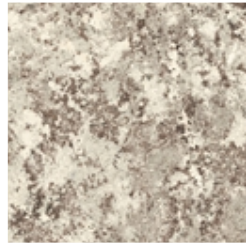

Céramique opaque
Alaska White

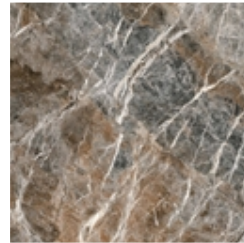

Céramique brillante
Mountain peak

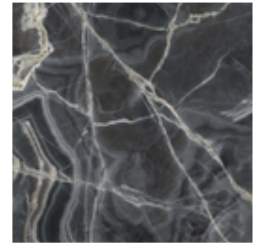

Céramique brillante
Black Onyx

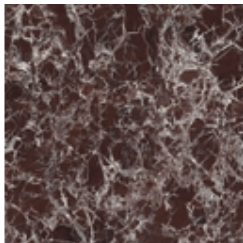

Céramique brillante
Rosso imperiale

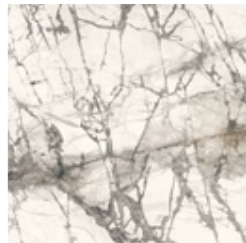

Céramique brillante
Imperial grey

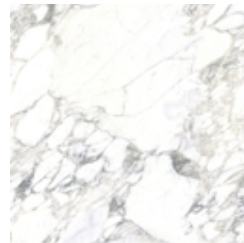

Céramique brillante
Calacatta

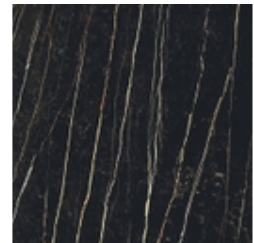

Céramique opaque
Laurent

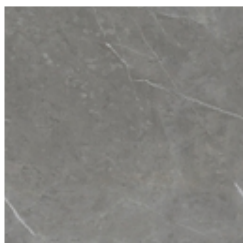

Céramique opaque
Gris Ardesia



Céramique finition soie
Calacatta macchia vecchia

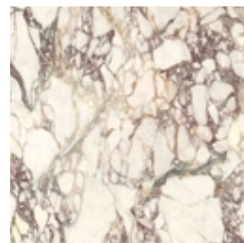

Céramique brillante
Calacatta Viola

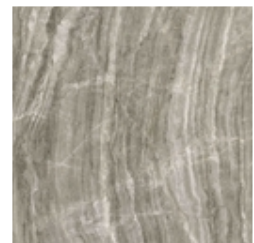

Céramique finition soie
Daino Grigio