

BONALDO

Gem

Designer: Marconato and Zappa



Gem is a family of coffee tables designed to create dynamic and versatile compositions: thanks to the variety of shapes, bases, sizes, heights, materials and finishes, Gem allows for ever-changing combinations. The top, available in glass or ceramic in a wide range of options, is enhanced by a thin perimeter frame in glossy lacquered wood, a precise, discreet yet distinctive edge that emphasises the purity of the form and highlights the material. The metal structure further enhances the design through two different combinations with the top: the base in bronze finish is paired with a glossy lacquered wood edge in glossy brown, while the base in lead finish is combined with a glossy lacquered wood edge in glossy grey, creating refined and coherent pairings.

Fiche de données

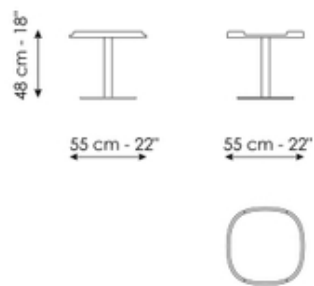

Gem high

Longueur: 55cm
Profondeur: 55cm
Hauteur: 48cm

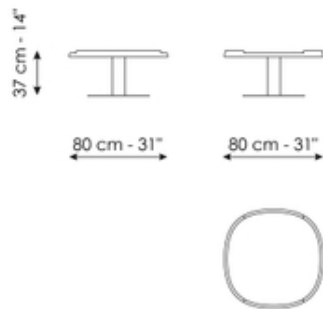

Gem medium

Longueur: 80cm
Profondeur: 80cm
Hauteur: 37cm

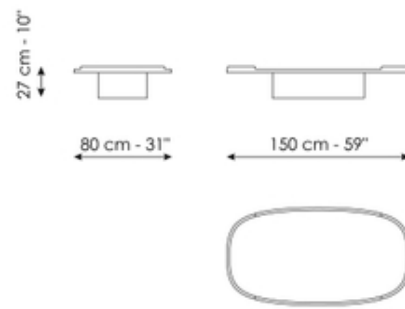

Gem low

Longueur: 150cm
Profondeur: 80cm
Hauteur: 27cm

Finishes

Plateau



Céramique opaque
Augusta

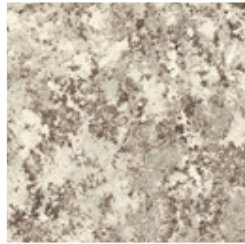

Céramique opaque
Alaska White

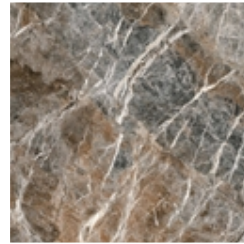

Céramique brillante
Mountain peak

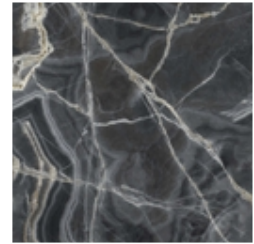

Céramique brillante
Black Onyx

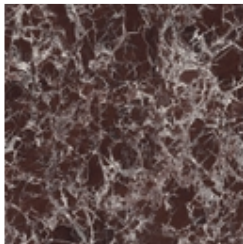

Céramique brillante
Rosso imperiale

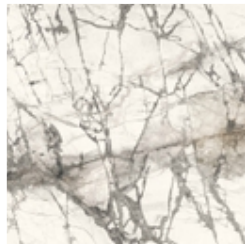

Céramique brillante
Imperial grey

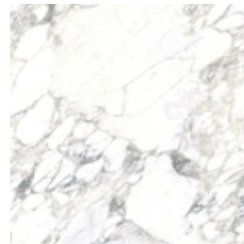

Céramique brillante
Calacatta

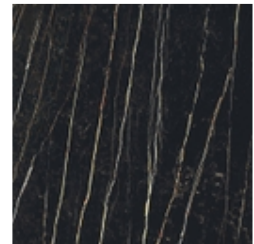

Céramique opaque
Laurent

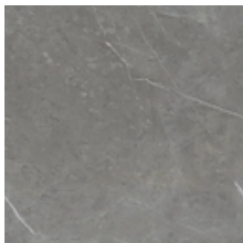

Céramique opaque
Gris Ardesia

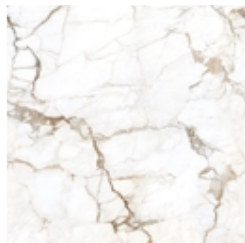

Céramique finition soie
Calacatta macchia vecchia

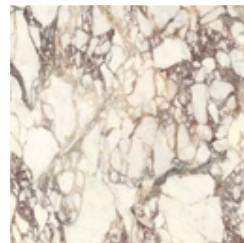

Céramique brillante
Calacatta Viola

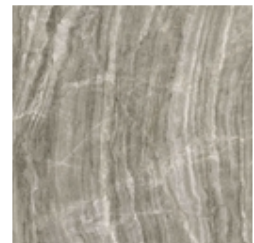

Céramique finition soie
Daino Grigio



Cristal
Glossy grey



Cristal
Glossy brown

OPTION BRONZE

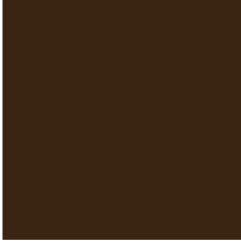

Bois laqué brillant
Glossy brown

OPTION BRONZE

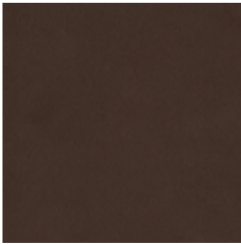

Métal verni
Bronze opaque

OPTION PLOMB



Bois laqué brillant
Glossy grey

OPTION PLOMB

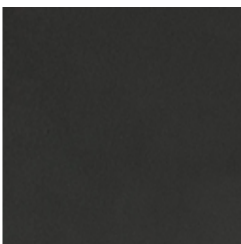

Métal verni
Plomb opaque

Les matériaux, tissus, cuirs, couleurs et finitions sont approximatifs et peuvent légèrement différer de la réalité. Vous pouvez retrouver la collection complète des tissus et cuirs Bonaldo sur le site <https://bonaldo.biz>